

# INSTRUCTION SHEET

A

B

39097

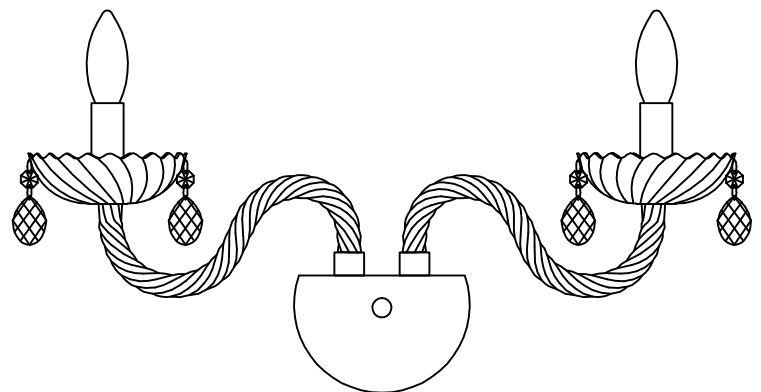
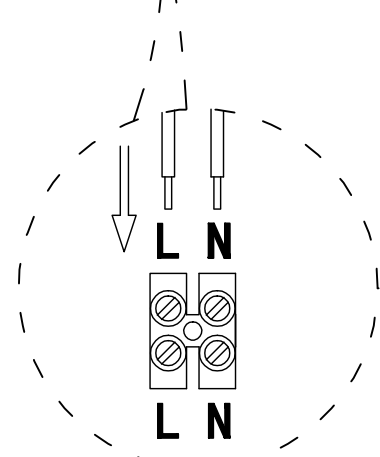
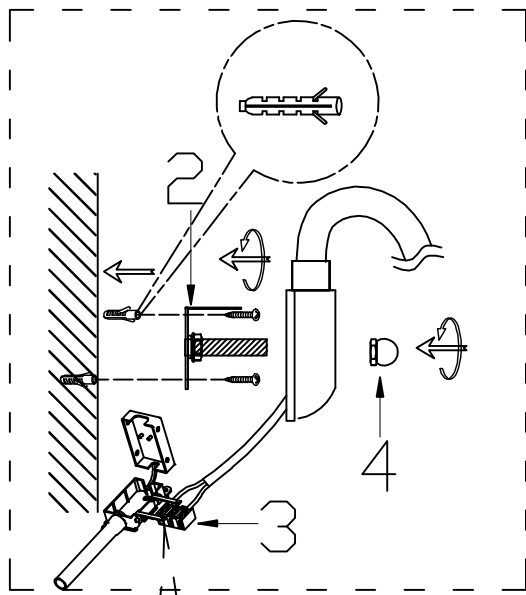
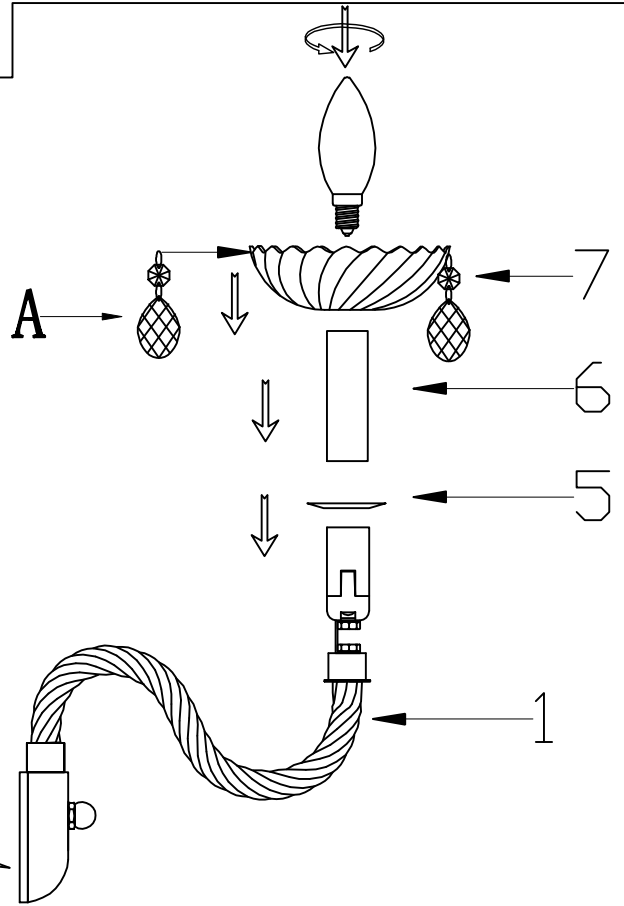
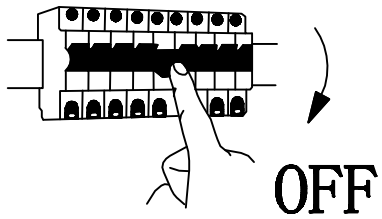

C

